

REV.	CHANGE	ECR	DATE	BY
A	XXXXX		XX/XX/XX	XX

SIZE	W	H	E	S	D	B
1/4	0.314	9/64	1/4	3/16	11/64	1/32
5/16	0.375	5/32	1/4	1/4	15/64	1/16
3/8	0.438	5/32	1/4	5/16	15/64	1/16
7/16	0.500	5/32	1/4	5/16	19/64	1/16
1/2	0.562	3/16	3/8	3/8	19/64	1/16
5/8	0.689	3/16	3/8	1/2	19/64	1/16
3/4	0.812	3/16	XX	XX	19/64	1/16
15/16	0.995	1/4	XX	XX	19/64	1/16

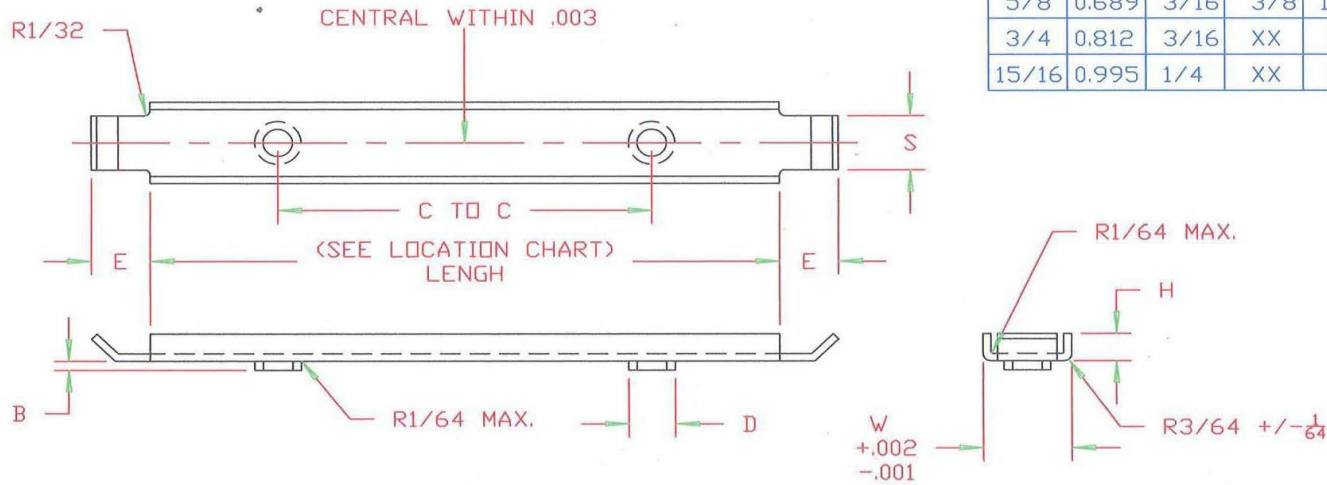

ELECTRO - GALVANIZED C.R.S. - .028 THICK

MATERIAL:

- 1.) BREAK ALL UNNECESSARY SHARP EDGES.
- 2.) ALL GROUND SURFACES TO BE TRUE AND SQUARE.
- 3.) DIMENSIONS MARKED (M) REQUIRE TOOL INSPECTION REPORTS.
- 4.) MARK DRWG.NO.AND DATE ON EACH DETAIL.

TOLERANCES UNLESS OTHERWISE SPECIFIED	
FRACTIONS ±1/64	ANGLES ±1/2°
2 PLACE ± .01	
3 PLACE ± .005	
4 PLACE ± .0005	

C.A.D.FILE # HOLDER



SENK TOOLING INC.
OWOSSO, MICHIGAN 48867

SCALE: DO NOT SCALE
DATE: 11/15/05

DRAWN BY: LS
APPROV. BY:

HOLDER DRAWING

DRAWING NUMBER:
110515

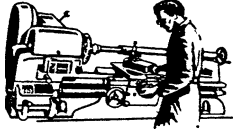

SENK TOOLING INC.

1117 E. Henderson Rd.
Owosso, MI. 48867

Phone: 989-725-6067
Fax: 989-723-5220

November 1 2012

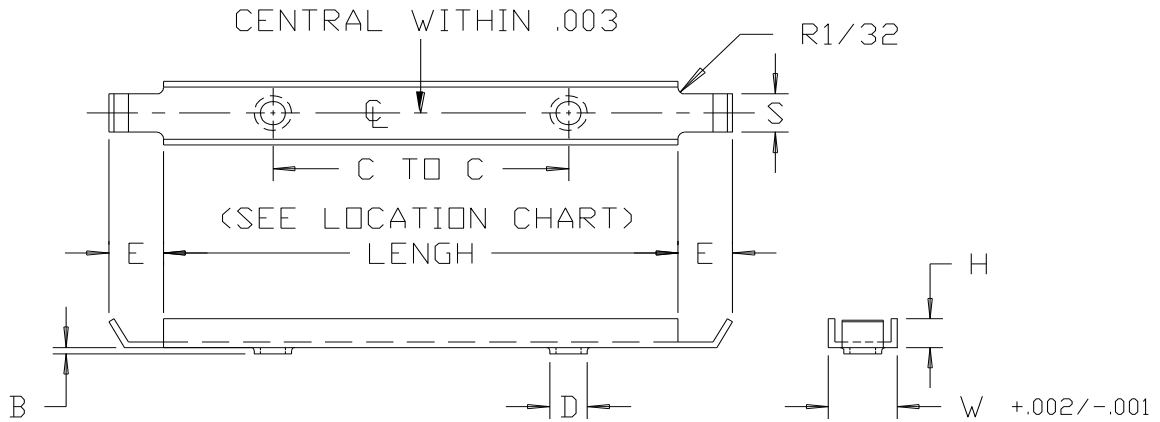

HONE HOLDER
MATERIAL : ELECTRO - GALVANIZED C.R.S. -.028 THICK

SIZE	W	H	E	S	D	B
1/4	0.314	9/64	1/4	3/16	11/64	1/32
5/16	0.375	5/32	1/4	1/4	15/64	1/16
3/8	0.438	5/32	1/4	5/16	15/64	1/16
7/16	0.500	5/32	1/4	5/16	19/64	1/16
1/2	0.562	3/16	3/8	3/8	19/64	1/16
5/8	0.689	3/16	3/8	1/2	19/64	1/16
3/4	0.812	3/16	---	---	19/64	1/16
15/16	0.995	1/4	---	---	19/64	1/16

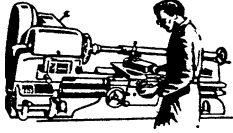

SENK TOOLING INC.

1117 E. Henderson Rd. Phone: 989-725-6067
 Owosso, MI. 48867 Fax: 989-723-5220

April 1 2015

HONE HOLDER PRICE SHEET

ALL PRICES..NET 30 DAYS
 ALL ORDERS..PLUS SHIPPING

QUANTITY	1/4 X 4 NO HOOKS C / C 2 3/8	1/4 X 4 2 HOOKS C / C 2 3/8	1/4 X 6 NO HOOKS C / C 2 3/8	1/4 X 6 2 HOOKS C / C 2 3/8
500	\$ 0.1665	\$ 0.1698	\$ 0.1767	\$ 0.1794
1000	\$ 0.1574	\$ 0.1608	\$ 0.1675	\$ 0.1623
2000	\$ 0.1486	\$ 0.1517	\$ 0.1583	\$ 0.1613
3000	\$ 0.1393	\$ 0.1436	\$ 0.1491	\$ 0.1522
4000	\$ 0.1303	\$ 0.1335	\$ 0.1402	\$ 0.1437
5000	\$ 0.1211	\$ 0.1243	\$ 0.1312	\$ 0.1342
6000	\$ 0.1120	\$ 0.1154	\$ 0.1221	\$ 0.1250
8000	\$ 0.1030	\$ 0.1062	\$ 0.1130	\$ 0.1160
10000	\$ 0.0940	\$ 0.0973	\$ 0.1039	\$ 0.1070
15000	\$ 0.0894	\$ 0.0927	\$ 0.0950	\$ 0.0979
25000	\$ 0.0870	\$ 0.0903	\$ 0.0923	\$ 0.0956
40000	\$ 0.0848	\$ 0.0880	\$ 0.0908	\$ 0.0937

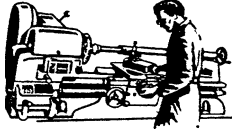

SENK TOOLING INC.

1117 E. Henderson Rd.
Owosso, MI. 48867

Phone: 989-725-6067
Fax: 989-723-5220

April 1 2015

HONE HOLDER PRICE SHEET

ALL PRICES..NET 30 DAYS
ALL ORDERS..PLUS SHIPPING

QUANTITY	1/4 X 3	1/4 X 4
PRICE PER EACH	NO HOOKS NO DOWELS	NO HOOKS NO DOWELS
500	\$ 0.1632	\$ 0.1665
1000	\$ 0.1542	\$ 0.1573
2000	\$ 0.1451	\$ 0.1482
3000	\$ 0.1360	\$ 0.1392
4000	\$ 0.1269	\$ 0.1303
5000	\$ 0.1179	\$ 0.1211
6000	\$ 0.1087	\$ 0.1119
8000	\$ 0.0997	\$ 0.1029
10000	\$ 0.0908	\$ 0.0940
15000	\$ 0.0862	\$ 0.0894
25000	\$ 0.0836	\$ 0.0869
40000	\$ 0.0814	\$ 0.0848

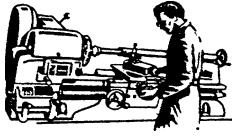

SENK TOOLING INC.

1117 E. Henderson Rd.
Owosso, MI. 48867

April 1 2015

HONE HOLDER PRICE SHEET

ALL PRICES..NET 30 DAYS
ALL ORDERS..PLUS SHIPPING

QUANTITY	1/4 X 3 NO HOOKS C/C 1 1/2	1/4 X 3 NO HOOKS C/C 2 3/8
500	\$ 0.1632	\$ 0.1665
1000	\$ 0.1542	\$ 0.1573
2000	\$ 0.1451	\$ 0.1482
3000	\$ 0.1360	\$ 0.1392
4000	\$ 0.1269	\$ 0.1303
5000	\$ 0.1179	\$ 0.1211
6000	\$ 0.1087	\$ 0.1119
8000	\$ 0.0997	\$ 0.1029
10000	\$ 0.0908	\$ 0.0940
15000	\$ 0.0862	\$ 0.0894
25000	\$ 0.0836	\$ 0.0869
40000	\$ 0.0814	\$ 0.0848

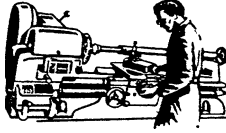

SENK TOOLING INC.

1117 E. Henderson Rd.
 Oshtemo, MI. 48867

Phone: 989-725-6067
 Fax: 989-723-5220

April 1 2015

HONE HOLDER PRICE SHEET

ALL PRICES..NET 30 DAYS
 ALL ORDERS..PLUS SHIPPING

QUANTITY	5/16 X 1 1/4 PRICE PER EACH NO HOOKS C / C 1"	5/16 X 1 1/2 NO HOOKS 1 DOWEL CENTER OR 3/8 FROM END	5/16 X 1 5/8 NO HOOKS C / C 1"	5/16 X 1 5/8 2 HOOKS C / C 1"
500	\$ 0.1546	\$ 0.1552	\$ 0.1653	\$ 0.1655
1000	\$ 0.1456	\$ 0.1620	\$ 0.1565	\$ 0.1566
2000	\$ 0.1371	\$ 0.1371	\$ 0.1473	\$ 0.1474
3000	\$ 0.1275	\$ 0.1280	\$ 0.1382	\$ 0.1383
4000	\$ 0.1185	\$ 0.1188	\$ 0.1290	\$ 0.1293
5000	\$ 0.1094	\$ 0.1099	\$ 0.1202	\$ 0.1203
6000	\$ 0.1003	\$ 0.1009	\$ 0.1112	\$ 0.1135
8000	\$ 0.0957	\$ 0.0961	\$ 0.1020	\$ 0.1021
10000	\$ 0.0914	\$ 0.0918	\$ 0.0928	\$ 0.0930
15000	\$ 0.0866	\$ 0.0874	\$ 0.0882	\$ 0.0887
25000	\$ 0.0846	\$ 0.0849	\$ 0.0860	\$ 0.0862
40000	\$ 0.0819	\$ 0.0826	\$ 0.0835	\$ 0.0836

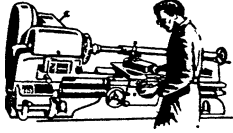

SENK TOOLING INC.

1117 E. Henderson Rd.
Owosso, MI. 48867

Phone: 989-725-6067
Fax: 989-723-5220

April 1 2015

HONE HOLDER PRICE SHEET

ALL PRICES..NET 30 DAYS
ALL ORDERS..PLUS SHIPPING

QUANTITY	5/16 X 2 NO HOOKS C / C 1" OR 1 3/8 1 3/4	5/16 X 2 2 HOOKS C / C 1" OR 1 3/8 1 3/4	5/16 X 2 1/4 NO HOOKS C / C 1 3/8 1 3/4	5/16 X 2 1/4 2 HOOKS C / C 1 3/8
500	\$ 0.1650	\$ 0.1682	\$ 0.1655	\$ 0.1684
1000	\$ 0.1560	\$ 0.1592	\$ 0.1566	\$ 0.1594
2000	\$ 0.1471	\$ 0.1551	\$ 0.1474	\$ 0.1504
3000	\$ 0.1379	\$ 0.1411	\$ 0.1383	\$ 0.1412
4000	\$ 0.1287	\$ 0.1320	\$ 0.1293	\$ 0.1321
5000	\$ 0.1197	\$ 0.1227	\$ 0.1203	\$ 0.1233
6000	\$ 0.1107	\$ 0.1140	\$ 0.1113	\$ 0.1141
8000	\$ 0.1015	\$ 0.1049	\$ 0.1021	\$ 0.1050
10000	\$ 0.0927	\$ 0.0957	\$ 0.0930	\$ 0.0958
15000	\$ 0.0878	\$ 0.0914	\$ 0.0887	\$ 0.0915
25000	\$ 0.0857	\$ 0.0889	\$ 0.0862	\$ 0.0891
40000	\$ 0.0832	\$ 0.0864	\$ 0.0836	\$ 0.0866

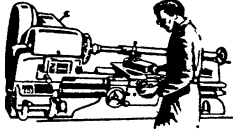

SENK TOOLING INC.

1117 E. Henderson Rd.
Owosso, MI. 48867

Phone: 989-725-6067
Fax: 989-723-5220

April 1 2015

HONE HOLDER PRICE SHEET

ALL PRICES..NET 30 DAYS
ALL ORDERS..PLUS SHIPPING

QUANTITY	5/16 X 2 1/2 NO HOOKS C / C 1 3/8 OR 2"	5/16 X 3 NO HOOKS C / C 1 3/8 1 3/4 OR 2"	5/16 X 3 2 HOOKS C / C 1 3/4 OR 2"	5/16 X 3 1/2 NO HOOKS C / C 2 3/8
500	\$ 0.1686	\$ 0.1688	\$ 0.1694	\$ 0.1690
1000	\$ 0.1594	\$ 0.1596	\$ 0.1602	\$ 0.1600
2000	\$ 0.1504	\$ 0.1506	\$ 0.1514	\$ 0.1508
3000	\$ 0.1412	\$ 0.1414	\$ 0.1422	\$ 0.1419
4000	\$ 0.1321	\$ 0.1325	\$ 0.1333	\$ 0.1327
5000	\$ 0.1233	\$ 0.1235	\$ 0.1240	\$ 0.1238
6000	\$ 0.1141	\$ 0.1140	\$ 0.1148	\$ 0.1146
8000	\$ 0.1050	\$ 0.1051	\$ 0.1060	\$ 0.1055
10000	\$ 0.0958	\$ 0.0961	\$ 0.0969	\$ 0.0966
15000	\$ 0.0915	\$ 0.0917	\$ 0.0922	\$ 0.0920
25000	\$ 0.0891	\$ 0.0893	\$ 0.0899	\$ 0.0895
40000	\$ 0.0866	\$ 0.0868	\$ 0.0876	\$ 0.0874

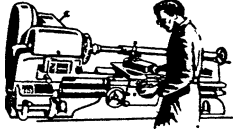

SENK TOOLING INC.

1117 E. Henderson Rd.
Owosso, MI. 48867

Phone: 989-725-6067
Fax: 989-723-5220

April 1 2015

HONE HOLDER PRICE SHEET

ALL PRICES..NET 30 DAYS
ALL ORDERS..PLUS SHIPPING

QUANTITY	5/16 X 3 1/2	5/16 X 4	5/16 X 4
PRICE PER EACH	2 HOOKS	NO HOOKS	2 HOOKS
	C / C	C / C	C / C
	2 3/8	2 3/8	2 3/8
500	\$ 0.1711	\$ 0.1707	\$ 0.1729
1000	\$ 0.1619	\$ 0.1615	\$ 0.1640
2000	\$ 0.1528	\$ 0.1526	\$ 0.1546
3000	\$ 0.1439	\$ 0.1437	\$ 0.1456
4000	\$ 0.1347	\$ 0.1346	\$ 0.1366
5000	\$ 0.1255	\$ 0.1252	\$ 0.1275
6000	\$ 0.1165	\$ 0.1163	\$ 0.1185
8000	\$ 0.1076	\$ 0.1074	\$ 0.1095
10000	\$ 0.0985	\$ 0.0983	\$ 0.1003
15000	\$ 0.0939	\$ 0.0935	\$ 0.0957
25000	\$ 0.0917	\$ 0.0914	\$ 0.0934
40000	\$ 0.0892	\$ 0.0891	\$ 0.0910

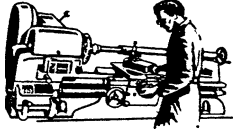

SENK TOOLING INC.

1117 E. Henderson Rd.
Owosso, MI. 48867

Phone: 989-725-6067
Fax: 989-723-5220

April 1 2015

HONE HOLDER PRICE SHEET

ALL PRICES..NET 30 DAYS
ALL ORDERS..PLUS SHIPPING

QUANTITY	5/16 X 5 NO HOOKS C / C 2 3/8	5/16 X 5 2 HOOKS C / C 2 3/8	5/16 X 6 NO HOOKS C / C 2 3/8 OR 4"
500	\$ 0.1775	\$ 0.1798	\$ 0.1804
1000	\$ 0.1687	\$ 0.1706	\$ 0.1712
2000	\$ 0.1596	\$ 0.1614	\$ 0.1623
3000	\$ 0.1505	\$ 0.1525	\$ 0.1532
4000	\$ 0.1458	\$ 0.1436	\$ 0.1440
5000	\$ 0.1321	\$ 0.1344	\$ 0.1348
6000	\$ 0.1235	\$ 0.1254	\$ 0.1258
8000	\$ 0.1142	\$ 0.1162	\$ 0.1169
10000	\$ 0.1051	\$ 0.1074	\$ 0.1078
15000	\$ 0.0961	\$ 0.0984	\$ 0.0987
25000	\$ 0.0939	\$ 0.0958	\$ 0.0961
40000	\$ 0.0921	\$ 0.0941	\$ 0.0944

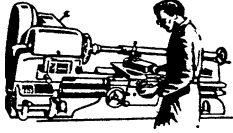

SENK TOOLING INC.

1117 E. Henderson Rd.
Owosso, MI. 48867

Phone: 989-725-6067
Fax: 989-723-5220

April 1 2015

HONE HOLDER PRICE SHEET

ALL PRICES..NET 30 DAYS
ALL ORDERS..PLUS SHIPPING

QUANTITY	0.380	5/16 X 6	0.380
PRICE PER EACH	OVERSIZE	2 HOOKS	OVERSIZE
	5/16 X 6	C / C	5/16 X 6
	NO HOOKS	2 3/8	2 HOOKS
	C / C	OR 4"	C / C
	2 3/8 OR 4"		2 3/8 OR 4"

500	\$ 0.1984	\$ 0.1842	\$ 0.2021
1000	\$ 0.1894	\$ 0.1751	\$ 0.1931
2000	\$ 0.1804	\$ 0.1660	\$ 0.1842
3000	\$ 0.1712	\$ 0.1569	\$ 0.1751
4000	\$ 0.1623	\$ 0.1479	\$ 0.1660
5000	\$ 0.1532	\$ 0.1387	\$ 0.1569
6000	\$ 0.1440	\$ 0.1296	\$ 0.1479
8000	\$ 0.1348	\$ 0.1206	\$ 0.1387
10000	\$ 0.1258	\$ 0.1116	\$ 0.1296
15000	\$ 0.1169	\$ 0.1024	\$ 0.1206
25000	\$ 0.1145	\$ 0.1001	\$ 0.1183
40000	\$ 0.1127	\$ 0.0984	\$ 0.1163

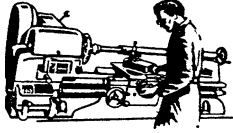

SENK TOOLING INC.

1117 E. Henderson Rd.
Owosso, MI. 48867

Phone: 989-725-6067
Fax: 989-723-5220

April 1 2015

HONE HOLDER PRICE SHEET

ALL PRICES..NET 30 DAYS
ALL ORDERS..PLUS SHIPPING

QUANTITY	3/8 X 1 1/4 NO HOOKS 1 DOWEL CENTER	3/8 X 2 1/2 NO HOOKS C / C 1 3/4	3/8 X 3 NO HOOKS C / C 1 3/4 2 3/8	3/8 X 3 1/2 NO HOOKS C / C 1 3/4 2 3/8
500	\$ 0.1561	\$ 0.1717	\$ 0.1721	\$ 0.1892
1000	\$ 0.1471	\$ 0.1626	\$ 0.1631	\$ 0.1794
2000	\$ 0.1381	\$ 0.1538	\$ 0.1540	\$ 0.1693
3000	\$ 0.1289	\$ 0.1446	\$ 0.1450	\$ 0.1594
4000	\$ 0.1199	\$ 0.1356	\$ 0.1359	\$ 0.1493
5000	\$ 0.1110	\$ 0.1263	\$ 0.1268	\$ 0.1396
6000	\$ 0.1019	\$ 0.1174	\$ 0.1179	\$ 0.1296
8000	\$ 0.0927	\$ 0.1082	\$ 0.1085	\$ 0.1195
10000	\$ 0.0899	\$ 0.0992	\$ 0.0996	\$ 0.1094
15000	\$ 0.0863	\$ 0.0949	\$ 0.0952	\$ 0.1045
25000	\$ 0.0857	\$ 0.0922	\$ 0.0927	\$ 0.1019
40000	\$ 0.0817	\$ 0.0899	\$ 0.0903	\$ 0.0993

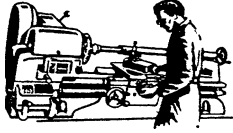

SENK TOOLING INC.

1117 E. Henderson Rd.
Owosso, MI. 48867

Phone: 989-725-6067
Fax: 989-723-5220

April 1 2015

HONE HOLDER PRICE SHEET

ALL PRICES..NET 30 DAYS
ALL ORDERS..PLUS SHIPPING

QUANTITY	3/8 X 4 NO HOOKS C / C 1 3/4 OR 2 3/8	3/8 X 4 2 HOOKS C / C 1 3/4 OR 2 3/8	3/8 X 5 NO HOOKS C / C 2 3/8
500	\$ 0.1724	\$ 0.1802	\$ 0.1767
1000	\$ 0.1634	\$ 0.1711	\$ 0.1673
2000	\$ 0.1544	\$ 0.1620	\$ 0.1584
3000	\$ 0.1452	\$ 0.1529	\$ 0.1491
4000	\$ 0.1361	\$ 0.1440	\$ 0.1405
5000	\$ 0.1273	\$ 0.1347	\$ 0.1312
6000	\$ 0.1181	\$ 0.1256	\$ 0.1221
8000	\$ 0.1091	\$ 0.1165	\$ 0.1130
10000	\$ 0.0998	\$ 0.1077	\$ 0.1039
15000	\$ 0.0955	\$ 0.0987	\$ 0.0993
25000	\$ 0.0930	\$ 0.0963	\$ 0.0972
40000	\$ 0.0908	\$ 0.0944	\$ 0.0945

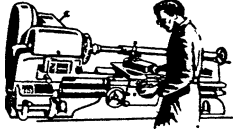

SENK TOOLING INC.

1117 E. Henderson Rd.
Owosso, MI. 48867

Phone: 989-725-6067
Fax: 989-723-5220

April 1 2015

HONE HOLDER PRICE SHEET

ALL PRICES..NET 30 DAYS
ALL ORDERS..PLUS SHIPPING

QUANTITY	3/8 X 5 2 HOOKS C / C 2 3/8	3/8 X 6 NO HOOKS C / C 2 3/8	3/8 X 6 2 HOOKS C / C 2 3/8
500	\$ 0.1842	\$ 0.1848	\$ 0.1889
1000	\$ 0.1751	\$ 0.1756	\$ 0.1798
2000	\$ 0.1660	\$ 0.1666	\$ 0.1706
3000	\$ 0.1569	\$ 0.1575	\$ 0.1614
4000	\$ 0.1350	\$ 0.1486	\$ 0.1525
5000	\$ 0.1296	\$ 0.1395	\$ 0.1436
6000	\$ 0.1268	\$ 0.1304	\$ 0.1344
8000	\$ 0.1206	\$ 0.1215	\$ 0.1254
10000	\$ 0.1116	\$ 0.1122	\$ 0.1162
15000	\$ 0.1026	\$ 0.1032	\$ 0.1074
25000	\$ 0.1003	\$ 0.1009	\$ 0.1049
40000	\$ 0.0985	\$ 0.0990	\$ 0.1030

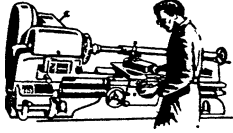

SENK TOOLING INC.

1117 E. Henderson Rd.
Owosso, MI. 48867

Phone: 989-725-6067
Fax: 989-723-5220

April 1 2015

HONE HOLDER PRICE SHEET

ALL PRICES..NET 30 DAYS
ALL ORDERS..PLUS SHIPPING

QUANTITY	3/8 X 8 NO HOOKS C / C 5 1/2	OVERSIZE 0.442 3/8 X 8 NO HOOKS C / C 5 1/2 LARGE DOWELS	3/8 X 8 2 HOOKS C / C 5 1/2
----------	---------------------------------------	--	--------------------------------------

500	\$ 0.1971	\$ 0.2153	\$ 0.2011
1000	\$ 0.1879	\$ 0.2063	\$ 0.1920
2000	\$ 0.1788	\$ 0.1971	\$ 0.1831
3000	\$ 0.1701	\$ 0.1879	\$ 0.1739
4000	\$ 0.1609	\$ 0.1788	\$ 0.1648
5000	\$ 0.1519	\$ 0.1701	\$ 0.1557
6000	\$ 0.1427	\$ 0.1609	\$ 0.1468
8000	\$ 0.1338	\$ 0.1519	\$ 0.1378
10000	\$ 0.1246	\$ 0.1427	\$ 0.1286
15000	\$ 0.1156	\$ 0.1338	\$ 0.1195
25000	\$ 0.1064	\$ 0.1246	\$ 0.1105
40000	\$ 0.1042	\$ 0.1222	\$ 0.1081

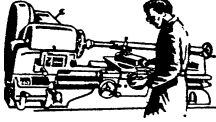

SENK TOOLING INC.

1117 E. Henderson Rd.
Owosso, MI. 48867

Phone: 989-725-6067
Fax: 989-723-5220

April 1 2015

HONE HOLDER PRICE SHEET

ALL PRICES..NET 30 DAYS
ALL ORDERS..PLUS SHIPPING

QUANTITY	STANDARD	STANDARD
PRICE PER EACH	0.4395	0.4395
	3/8 X 8	3/8 X 8
	NO HOOKS	2 HOOKS
	C / C	C / C
	5 1/2	5 1/2
	LARGE DOWELS	LARGE DOWELS
500	\$ 0.2153	\$ 0.2193
1000	\$ 0.2063	\$ 0.2102
2000	\$ 0.1971	\$ 0.2010
3000	\$ 0.1879	\$ 0.1918
4000	\$ 0.1788	\$ 0.1828
5000	\$ 0.1701	\$ 0.1739
6000	\$ 0.1609	\$ 0.1648
8000	\$ 0.1519	\$ 0.1557
10000	\$ 0.1427	\$ 0.1467
15000	\$ 0.1338	\$ 0.1376
25000	\$ 0.1246	\$ 0.1283
40000	\$ 0.1222	\$ 0.1262

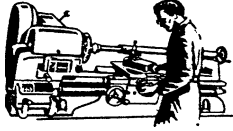

SENK TOOLING INC.

1117 E. Henderson Rd.
Owosso, MI. 48867

Phone: 989-725-6067
Fax: 989-723-5220

April 1 2015

HONE HOLDER PRICE SHEET

ALL PRICES..NET 30 DAYS
ALL ORDERS..PLUS SHIPPING

QUANTITY	7/16 X 2 NO HOOKS C / C 1 3/8	7/16 X 2 2 HOOKS C / C 1 3/8	7/16 X 4 NO HOOKS C / C 2 3/8
500	\$ 0.1702	\$ 0.1705	\$ 0.1729
1000	\$ 0.1611	\$ 0.1613	\$ 0.1640
2000	\$ 0.1520	\$ 0.1522	\$ 0.1546
3000	\$ 0.1428	\$ 0.1434	\$ 0.1456
4000	\$ 0.1341	\$ 0.1343	\$ 0.1366
5000	\$ 0.1249	\$ 0.1252	\$ 0.1275
6000	\$ 0.1157	\$ 0.1160	\$ 0.1185
8000	\$ 0.1065	\$ 0.1070	\$ 0.1094
10000	\$ 0.0975	\$ 0.0980	\$ 0.1003
15000	\$ 0.0930	\$ 0.0934	\$ 0.0957
25000	\$ 0.0908	\$ 0.0910	\$ 0.0934
40000	\$ 0.0882	\$ 0.0888	\$ 0.0910

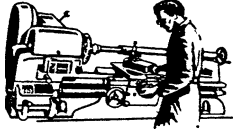

SENK TOOLING INC.

1117 E. Henderson Rd.
Owosso, MI. 48867

Phone: 989-725-6067
Fax: 989-723-5220

April 1 2015

HONE HOLDER PRICE SHEET

ALL PRICES..NET 30 DAYS
ALL ORDERS..PLUS SHIPPING

QUANTITY	7/16 X 4	7/16 X 5	7/16 X 5
PRICE PER EACH	2 HOOKS	NO HOOKS	2 HOOKS
	C / C	C / C	C / C
	2 3/8	2 3/8	2 3/8

500	\$ 0.1774	\$ 0.1815	\$ 0.1854
1000	\$ 0.1686	\$ 0.1724	\$ 0.1767
2000	\$ 0.1594	\$ 0.1634	\$ 0.1675
3000	\$ 0.1504	\$ 0.1544	\$ 0.1583
4000	\$ 0.1412	\$ 0.1452	\$ 0.1491
5000	\$ 0.1321	\$ 0.1361	\$ 0.1402
6000	\$ 0.1233	\$ 0.1273	\$ 0.1312
8000	\$ 0.1141	\$ 0.1181	\$ 0.1221
10000	\$ 0.1127	\$ 0.1091	\$ 0.1130
15000	\$ 0.1050	\$ 0.1001	\$ 0.1050
25000	\$ 0.0981	\$ 0.0976	\$ 0.1019
40000	\$ 0.0957	\$ 0.0958	\$ 0.0998

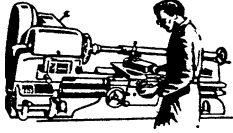

SENK TOOLING INC.

1117 E. Henderson Rd.
Owosso, MI. 48867

Phone: 989-725-6067
Fax: 989-723-5220

April 1 2015

HONE HOLDER PRICE SHEET

ALL PRICES..NET 30 DAYS
ALL ORDERS..PLUS SHIPPING

QUANTITY	7/16 X 6 NO HOOKS C / C 2 3/8	7/16 X 6 2 HOOKS C / C 2 3/8	7/16 X 8 NO HOOKS C / C 5 1/2	7/16 X 8 2 HOOKS C / C 5 1/2
500	\$ 0.1857	\$ 0.1920	\$ 0.2007	\$ 0.2049
1000	\$ 0.1768	\$ 0.1831	\$ 0.1915	\$ 0.1958
2000	\$ 0.1676	\$ 0.1739	\$ 0.1827	\$ 0.1866
3000	\$ 0.1585	\$ 0.1648	\$ 0.1735	\$ 0.1774
4000	\$ 0.1492	\$ 0.1557	\$ 0.1646	\$ 0.1686
5000	\$ 0.1405	\$ 0.1468	\$ 0.1554	\$ 0.1594
6000	\$ 0.1314	\$ 0.1378	\$ 0.1465	\$ 0.1504
8000	\$ 0.1222	\$ 0.1286	\$ 0.1375	\$ 0.1412
10000	\$ 0.1131	\$ 0.1195	\$ 0.1281	\$ 0.1321
15000	\$ 0.1042	\$ 0.1105	\$ 0.1192	\$ 0.1233
25000	\$ 0.1019	\$ 0.1081	\$ 0.1100	\$ 0.1141
40000	\$ 0.0998	\$ 0.1062	\$ 0.1078	\$ 0.1117

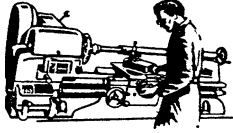

SENK TOOLING INC.

1117 E. Henderson Rd.
Owosso, MI. 48867

Phone: 989-725-6067
Fax: 989-723-5220

April 1 2015

HONE HOLDER PRICE SHEET

ALL PRICES..NET 30 DAYS
ALL ORDERS..PLUS SHIPPING

QUANTITY	1/2 X 3 NO HOOKS 1 DOWEL	1/2 X 4 NO HOOKS C / C 2 3/8	1/2 X 4 2 HOOKS C / C 2 3/8
500	\$ 0.1660	\$ 0.1732	\$ 0.1791
1000	\$ 0.1569	\$ 0.1641	\$ 0.1702
2000	\$ 0.1479	\$ 0.1549	\$ 0.1611
3000	\$ 0.1387	\$ 0.1458	\$ 0.1522
4000	\$ 0.1296	\$ 0.1367	\$ 0.1428
5000	\$ 0.1206	\$ 0.1278	\$ 0.1341
6000	\$ 0.1116	\$ 0.1186	\$ 0.1249
8000	\$ 0.1024	\$ 0.1095	\$ 0.1157
10000	\$ 0.0934	\$ 0.1002	\$ 0.1065
15000	\$ 0.0889	\$ 0.0958	\$ 0.1021
25000	\$ 0.0864	\$ 0.0935	\$ 0.0997
40000	\$ 0.0842	\$ 0.0914	\$ 0.0974

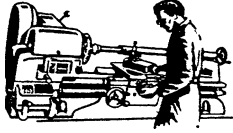

SENK TOOLING INC.

1117 E. Henderson Rd.
Owosso, MI. 48867

Phone: 989-725-6067
Fax: 989-723-5220

April 1 2015

HONE HOLDER PRICE SHEET

ALL PRICES..NET 30 DAYS
ALL ORDERS..PLUS SHIPPING

QUANTITY	1/2 X 4 NO HOOKS C / C 2 3/8 DOWEL 1 1/16 FROM END	1/2 X 4 BOX END C / C 2 3/8
500	\$ 0.1732	\$ 0.1955
1000	\$ 0.1641	\$ 0.1866
2000	\$ 0.1549	\$ 0.1774
3000	\$ 0.1458	\$ 0.1686
4000	\$ 0.1367	\$ 0.1594
5000	\$ 0.1278	\$ 0.1504
6000	\$ 0.1186	\$ 0.1412
8000	\$ 0.1095	\$ 0.1320
10000	\$ 0.1006	\$ 0.1229
15000	\$ 0.0958	\$ 0.1186
25000	\$ 0.0935	\$ 0.1160
40000	\$ 0.0914	\$ 0.1140

1/2...PAGE 2

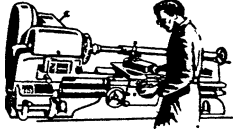

SENK TOOLING INC.

1117 E. Henderson Rd.
Owosso, MI. 48867

Phone: 989-725-6067
Fax: 989-723-5220

April 1 2015

HONE HOLDER PRICE SHEET

ALL PRICES..NET 30 DAYS
ALL ORDERS..PLUS SHIPPING

QUANTITY	1/2 X 5 NO HOOKS C / C 2 3/8	1/2 X 5 1 HOOK C / C 2 3/8
500	\$ 0.1817	\$ 0.1820
1000	\$ 0.1728	\$ 0.1730
2000	\$ 0.1635	\$ 0.1640
3000	\$ 0.1545	\$ 0.1544
4000	\$ 0.1453	\$ 0.1458
5000	\$ 0.1362	\$ 0.1367
6000	\$ 0.1274	\$ 0.1277
8000	\$ 0.1183	\$ 0.1185
10000	\$ 0.1093	\$ 0.1094
15000	\$ 0.1003	\$ 0.1007
25000	\$ 0.0980	\$ 0.0981
40000	\$ 0.0960	\$ 0.0963

1/2...PAGE 3

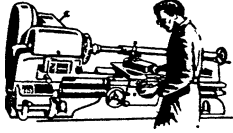

SENK TOOLING INC.

1117 E. Henderson Rd.
Owosso, MI. 48867

Phone: 989-725-6067
Fax: 989-723-5220

April 1 2015

HONE HOLDER PRICE SHEET

ALL PRICES..NET 30 DAYS
ALL ORDERS..PLUS SHIPPING

QUANTITY	1/2 X 6 NO HOOKS C / C 2 3/8	1/2 X 6 2 HOOKS C / C 2 3/8	SPECIAL 1/2 X 6 NO HOOKS C / C 5 1/2
500	\$ 0.1865	\$ 0.1932	\$ 0.2023
1000	\$ 0.1773	\$ 0.1844	\$ 0.1932
2000	\$ 0.1682	\$ 0.1752	\$ 0.1842
3000	\$ 0.1592	\$ 0.1663	\$ 0.1751
4000	\$ 0.1503	\$ 0.1571	\$ 0.1623
5000	\$ 0.1411	\$ 0.1481	\$ 0.1571
6000	\$ 0.1320	\$ 0.1389	\$ 0.1480
8000	\$ 0.1227	\$ 0.1298	\$ 0.1388
10000	\$ 0.1140	\$ 0.1208	\$ 0.1296
15000	\$ 0.1049	\$ 0.1117	\$ 0.1208
25000	\$ 0.1024	\$ 0.1094	\$ 0.1183
40000	\$ 0.1007	\$ 0.1077	\$ 0.1165

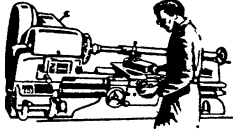

SENK TOOLING INC.

1117 E. Henderson Rd.
Owosso, MI. 48867

Phone: 989-725-6067
Fax: 989-723-5220

April 1 2015

HONE HOLDER PRICE SHEET

ALL PRICES..NET 30 DAYS
ALL ORDERS..PLUS SHIPPING

QUANTITY	1/2 X 8 NO HOOKS C / C 5 1/2	1/2 X 8 2 HOOKS C / C 5 1/2
500	\$ 0.2018	\$ 0.2085
1000	\$ 0.1929	\$ 0.1995
2000	\$ 0.1837	\$ 0.1906
3000	\$ 0.1747	\$ 0.1814
4000	\$ 0.1655	\$ 0.1722
5000	\$ 0.1566	\$ 0.1632
6000	\$ 0.1474	\$ 0.1542
8000	\$ 0.1383	\$ 0.1451
10000	\$ 0.1293	\$ 0.1360
15000	\$ 0.1203	\$ 0.1269
25000	\$ 0.1113	\$ 0.1180
40000	\$ 0.1090	\$ 0.1156

1/2...PAGE 5

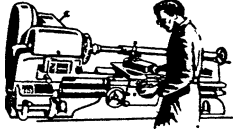

SENK TOOLING INC.

1117 E. Henderson Rd.
Owosso, MI. 48867

Phone: 989-725-6067
Fax: 989-723-5220

April 1 2015

HONE HOLDER PRICE SHEET

ALL PRICES..NET 30 DAYS
ALL ORDERS..PLUS SHIPPING

QUANTITY	5/8 X 5 NO HOOK C / C 2 3/8	5/8 X 6 NO HOOKS C / C 2 3/8	5/8 X 6 2 HOOKS C / C 2 3/8
500	\$ 0.1876	\$ 0.1954	\$ 0.2097
1000	\$ 0.1785	\$ 0.1865	\$ 0.2006
2000	\$ 0.1694	\$ 0.1773	\$ 0.1914
3000	\$ 0.1604	\$ 0.1682	\$ 0.1823
4000	\$ 0.1513	\$ 0.1592	\$ 0.1734
5000	\$ 0.1422	\$ 0.1503	\$ 0.1644
6000	\$ 0.1330	\$ 0.1411	\$ 0.1552
8000	\$ 0.1240	\$ 0.1320	\$ 0.1462
10000	\$ 0.1148	\$ 0.1227	\$ 0.1371
15000	\$ 0.1061	\$ 0.1140	\$ 0.1280
25000	\$ 0.1038	\$ 0.1116	\$ 0.1188
40000	\$ 0.1020	\$ 0.1096	\$ 0.1165

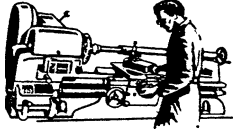

SENK TOOLING INC.

1117 E. Henderson Rd.
Owosso, MI. 48867

Phone: 989-725-6067
Fax: 989-723-5220

April 1 2015

HONE HOLDER PRICE SHEET

ALL PRICES..NET 30 DAYS
ALL ORDERS..PLUS SHIPPING

QUANTITY	5/8 X 8 NO HOOKS C / C 5 1/2	5/8 X 8 2 HOOKS C / C 5 1/2
500	\$ 0.2137	\$ 0.2206
1000	\$ 0.2047	\$ 0.2115
2000	\$ 0.1954	\$ 0.2023
3000	\$ 0.1865	\$ 0.1932
4000	\$ 0.1773	\$ 0.1844
5000	\$ 0.1682	\$ 0.1752
6000	\$ 0.1592	\$ 0.1663
8000	\$ 0.1503	\$ 0.1571
10000	\$ 0.1411	\$ 0.1481
15000	\$ 0.1320	\$ 0.1389
25000	\$ 0.1227	\$ 0.1298
40000	\$ 0.1206	\$ 0.1275

5/8...PAGE 2

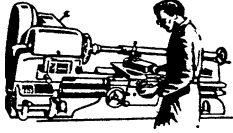

SENK TOOLING INC.

1117 E. Henderson Rd.
Owosso, MI. 48867

Phone: 989-725-6067
Fax: 989-723-5220

April 1 2015

HONE HOLDER PRICE SHEET

ALL PRICES..NET 30 DAYS
ALL ORDERS..PLUS SHIPPING

QUANTITY	3/4 X 8 NO HOOKS C / C 5 1/2	3/4 X 6 NO HOOKS C / C 2 3/8	3/4 X 6 NO HOOKS NO DOWELS
500	\$ 0.3222	\$ 0.3076	\$ 0.3076
1000	\$ 0.3131	\$ 0.2985	\$ 0.2985
2000	\$ 0.3040	\$ 0.2893	\$ 0.2893
3000	\$ 0.2951	\$ 0.2805	\$ 0.2805
4000	\$ 0.2862	\$ 0.2715	\$ 0.2715
5000	\$ 0.2770	\$ 0.2623	\$ 0.2623
6000	\$ 0.2678	\$ 0.2531	\$ 0.2531
8000	\$ 0.2587	\$ 0.2441	\$ 0.2441
10000	\$ 0.2497	\$ 0.2351	\$ 0.2351
15000	\$ 0.2407	\$ 0.2260	\$ 0.2260
25000	\$ 0.2316	\$ 0.2170	\$ 0.2170
40000	\$ 0.2293	\$ 0.2147	\$ 0.2147

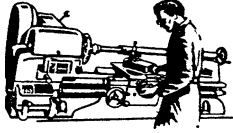

SENK TOOLING INC.

1117 E. Henderson Rd.
Owosso, MI. 48867

Phone: 989-725-6067
Fax: 989-723-5220

April 1 2015

HONE HOLDER PRICE SHEET

ALL PRICES..NET 30 DAYS
ALL ORDERS..PLUS SHIPPING

QUANTITY	15/16 X 4 NO HOOKS NO DOWELS	15/16 X 8 NO HOOKS C / C 5 1/2
500	\$ 0.3092	\$ 0.3618
1000	\$ 0.3003	\$ 0.3526
2000	\$ 0.2912	\$ 0.3435
3000	\$ 0.2821	\$ 0.3348
4000	\$ 0.2729	\$ 0.3256
5000	\$ 0.2638	\$ 0.3165
6000	\$ 0.2547	\$ 0.3073
8000	\$ 0.2459	\$ 0.2985
10000	\$ 0.2367	\$ 0.2892
15000	\$ 0.2321	\$ 0.2802
25000	\$ 0.2299	\$ 0.2710
40000	\$ 0.2275	\$ 0.2689